

Development of a platform with 2 DoF to assist the cooperation between grounded mobile robots and UAVs in landing operations

Emerson Kazuyoshi Kaneda

Research Centre in Digitalization and Intelligent Robotics (CeDRI), SusTEC, Instituto Politécnico de Bragança (IPB)
Bragança, Portugal
a61103@alunos.ipb.pt

Guido Berger

Research Centre in Digitalization and Intelligent Robotics (CeDRI), SusTEC, Instituto Politécnico de Bragança (IPB)
Bragança, Portugal
guido.berger@ipb.pt

Vitor Hugo Pinto

Research Center for Systems and Technologies (SYSTEC)
Faculty of Engineering of University of Porto (FEUP)
Porto, Portugal
vitorpinto@fe.up.pt

Milena Pinto

Centro Federal de Educação Tecnológica (CEFET/RJ)
Rio de Janeiro, Brasil
milena.pinto@cefet-rj.br

Murilo Ferreira

Centro Federal de Educação Tecnológica (CEFET/RJ)
Minas Gerais, Brasil
murillo.ferreira@cefetmg.br

Flávio Luiz Rossini

Universidade Tecnológica Federal do Paraná (UTFPR)
Campo Mourão, Brasil
frossini@utfpr.edu.br

José Lima

Research Centre in Digitalization and Intelligent Robotics (CeDRI), SusTEC, Instituto Politécnico de Bragança (IPB)
Bragança, Portugal
INESC TEC, Porto, Portugal
jllima@ipb.pt

Abstract—This paper presents the design and implementation of a two degrees of freedom (2 DoF) self-stabilizer platform based on a bidirectional type, intended to integrate with mobile robots to assist unmanned aerial vehicle (UAV) land operations in irregular grounds with a focus on outdoor environments operations. A study on the kinematics behavior of the bidirectional platform is addressed to improve decisions about the structure. Mind in the hardware and software implementation, the combination of step motors and IMU sensors provides the system with position control, how the step motor actuates over position with an integer number of steps, and a P controller generates an interesting response. This setup enabled the platform to stabilize in grounds with at least positive and negative 15 degrees of slope and maintain stability for UAVs under several operational conditions.

Index Terms—2 DoF Self-stabilizer, P Controller, IMU Sensor, exponential filter, 2 DoF kinematics

I. INTRODUCTION

Self-stabilizer platforms play a critical role in several technological applications since they provide stability and precision on irregular grounds. These platforms are designed to adjust automatically to external disturbances, ensuring the

surface remains level and steady [1]. Bidirectional platforms type, which offers 2 DoF for pitch and roll adjustments, are often used in simple stabilization tasks due to their straightforward design [2].

In the context of UAV land operations, a mobile robot can realize this operation in many types of ground able to be used in many areas like military, public safety, agriculture, monitoring, environmental preservation, wild firefighting [5], [6], [8], [11]. Some methods and algorithms are developed and tested to improve land operations and take-off operations, too [3], [4]. An economic role that receives huge benefits from this research is agriculture due to the UAV's ability to operate in farm terrains [9]. With this technology, mobile robots equipped with self-stabilizing platforms can navigate uneven terrains while providing a stable surface for UAV land, which significantly improves operational efficiency and versatility [1].

Moreover, self-stabilizer platforms in mobile robots enhanced a wide range of tasks. For instance, in search and rescue operations [7], [8], these robots can traverse rough terrains to deliver supplies or assist in evacuations and provide stability for sensitive equipment or heavy objects [12]. In

the agricultural environment, they can support precision farm-like harvest tasks realized by manipulators over self-stabilizer platforms [6], [9], [10]. Another role that robots are being used is in the forest. The most common mission inside this environment is to monitor and map through the use of UAV; on the other hand, the time for a drone in the air is no longer than half an hour, so the UAV needs some local to land safety [11]. This technology improves task performance and expands the potential applications of mobile robots, making them more adaptable and capable in various challenging environments.

Focused on the development of a self-stabilizing platform, this paper is organized in the following structure: the related works in section II, the kinematics of the 2 DoF bidirectional self-stabilizer platform in section III, hardware and software implementation in section IV, and the conclusion and future works in section V.

II. RELATED WORKS

An overview of many docking stations was made [13]. This study shows many types of static platforms and mobile platforms, which are made for specific applications like a simple docking station, a station to change the UAV battery using the hot swap concept, static self-leveling platforms, grounded mobile platforms, and aquatic mobile platforms. This study shows an evolution of the integration of concepts, like the hot swap battery on a land platform; however, the main interesting study for this paper is the concept of self-leveling integration on mobile platforms due to the capabilities to operate and cooperate with UAVs on irregular grounds.

An idea for self-leveling the platform over a mobile robot is using some gimbal structure. In the work of [14], a mobile platform carried a glass of water to analyze the stability of this gimbal structure. This structure actuates directly in the roll and pitch angles, making the kinematics more simple and easy to control. However, this structure needs two planes to stabilize, increasing the complexity of assembling this platform, the figure 1 of the work [14].

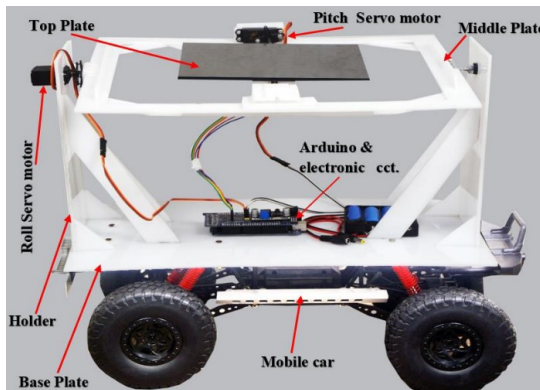

Fig. 1. Gimbal mobile platform [14]

About the type of the platform, another model besides a Gimbals platform is the use of delta or Stewart platforms; in the work of [18] developed a mobile robot with a Stewart

platform to stabilize the area of work. This platform has 6 DoF of complexity, so the complexity to control the stabilization is significantly increased. On the other hand, this structure supports high loads due to the structure. Figure 2 shows the physical prototype of the mobile platform constructed in the work of [18].



Fig. 2. Stewart Mobile Platform [18]

The application for these mobile platforms is for some functions, such as transporting delicate loads or facilitating transport on steep terrain, such as in the work of [12]. However, these mobile platforms can be useful in the cooperation of other types of robots; a simple cooperation is with mobile manipulators; in the work of [20] developed a 2 DoF self-stabilizer platform to cooperate with a manipulator to harvest bananas by picking operations.

Another cooperation with these mobile platforms is between UGV and AGV; the most common application of mobile platforms with UAV is the cooperation in land operations; however, on irregular or steep grounds, the AGV may fall down while landing or docked over the platform. Another cooperation between them is the hot-swap operation to recharge the UAV, the works of [15]–[17], [19] carried out their research on cooperation using the UGV as a land mobile platform. However, these works do not include self-leveling platforms because the tests are in flat and regular environments. One feature of this cooperation is the use of an image process to better localization of the UAV in the land process; this is an important consideration in developing a platform. Figure 3 shows a test of the work [16] where the UGV cooperated with UAV to realize the land operation while the UGV was moving.

As cited before, robots are used increasingly in many types of environments, like farms, wild firefighting, forests, and other places with uneven grounds. Based on those works, the development of the bidirectional platform for mobile robots in this present paper includes 2 DoF for direct action of pitch and roll angles, in addition to having a landing area large enough



Fig. 3. UAV Landing on UGV [16]

to contain fiducial markers for guidance and location of the UAV. Also, the kinematics complexity is not difficult due to the degrees of freedom; in spite of this, the maximum slope angle is designed to stabilize at least 15 degrees of tilt for each axis, the main advantages of this layout using rotatory motors and 2 DoF is the reduction of the cost once the linear actuators are more expensive than the rotatory motors, and the simple kinematics for each axis according to trigonometric relation in the section III made the system more easily to control, on the other hand, the effort of each engine will increase depending on the load.

III. PLATFORM KINEMATIC ANALYSIS

The structure of the 2 DoF platform actuates directly in pitch and roll angles. Ideally, the yaw angle does not change during stabilization, considering the rotation point as shown in Fig. 4. The reference point of origin for the pitch and roll angles must be aligned with a support point, which should be equipped with a universal joint to allow for mobility in both directions.

To control both angles, the analysis is over the mechanism layout of each actuator. Also the kinematics behavior is given by the length of the two arm; the Fig 5 illustrates a layout of the positioning of the actuator arm. It is visible in the figure the motor has a 180° of total effective angle since the actuation axis of the platform is aligned with the motor rotation axis.

This layout also sets up the height of the central support point, standardizing that at 0° the platform is horizontally stabilized on flat ground. In the first layout of Fig 5, the height of the platform is equal to the length of the second segment of the arm, while in the second layout, the height follows a trigonometric relationship of the arms as it forms a right triangle. Thus, the height between the motor axis and the platform plate is given by (1).

$$h = \sqrt{L_2^2 - L_1^2} \quad (1)$$

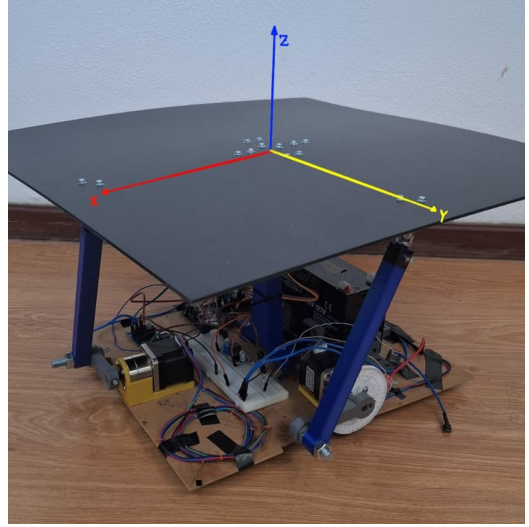

Fig. 4. Referential rotation point

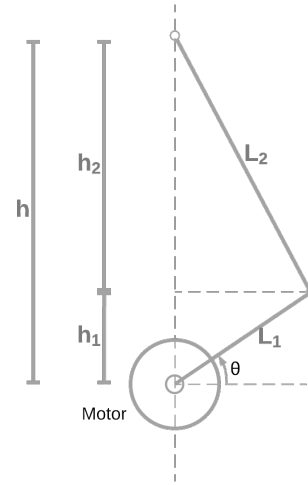

Fig. 5. Layout of the arm

Another important analysis in this structure is the maximum slope ϕ of each angle; this value is given by two values: the distance of the motors along the horizontal axis and the maximum and minimum height reached by the arm. Analyzing Fig. 6, the distance d between the central support and the motor shaft is static; however, the smaller this value, the greater the inclination angle.

According to Fig. 6, the slope function of roll and pitch angles is given by (2).

$$\phi(\theta) = \arctan \frac{h(\theta) - h_{cs}}{d} \quad (2)$$

Where $h(\theta)$ is given by (3)

$$h(\theta) = L_1 * \sin(\theta) + \sqrt{L_2^2 - (L_1 * \cos(\theta))^2} \quad (3)$$

For the platform structure developed in this paper, the values of each feature follow the Table I, for both actuators

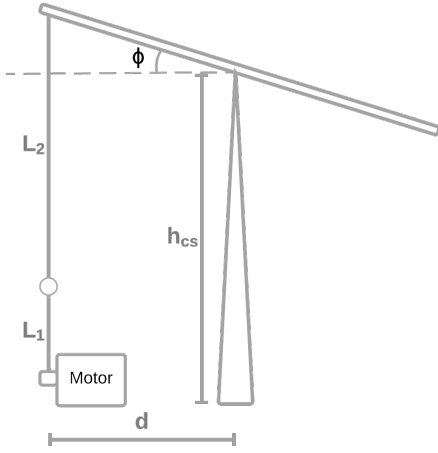

Fig. 6. Slope of the platform

TABLE I
LENGTH OF THE STRUCTURE

Feature	Value (mm)
h_{cs}	187.35
L_1	70
L_2	200
d	200

Based on these values, the cinematic behavior is given by the graphic in Fig 7; the figure shows -16 and 22.45 degrees of minimum and maximum slope angles, that is not symmetric due to the trigonometric behavior of the layout. However, this kinematics is independent for each axis, that is, one actuator does not influence the kinematics of the other.

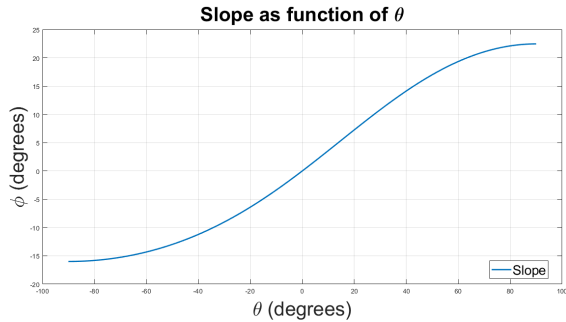

Fig. 7. Slope ϕ Kinematic behavior

IV. HARDWARE AND SOFTWARE IMPLEMENTATION

The methodology to develop this platform is based on 3 parts: the construction of the structure, the implementation of the controller, and the measurement of the angle to close the loop control. About the structure, the construction of the bidirectional structure was made using 3D printed structures according to table II. About the control of the slope, ϕ was implemented, a P controller to actuate the position of the motor. To measure the slope angle, an IMU sensor was

implemented, and then the signal provided by this sensor was filtered with an exponential moving average filter.

The hardware implemented for this 2 DoF self-stabilizer platform integrates several key components to ensure robust operation. The core processing unit is the ESP32 Wemos board, which interfaces with an ADXL345 IMU sensor via I2C communication to monitor pitch and roll angles. Data transmission is facilitated by an HC-12 wireless serial module, with a step-down buck converter providing regulated at 5V power supply. The motors are driven by DRV8825 step motor drivers with 32 micro-step configurations, ensuring accurate and reliable control. The system is supplied by a battery 12V 7Ah, which provides continuous power to maintain stability and functionality during operation.

All implementations can see more easily in the following flowchart in Fig 8.

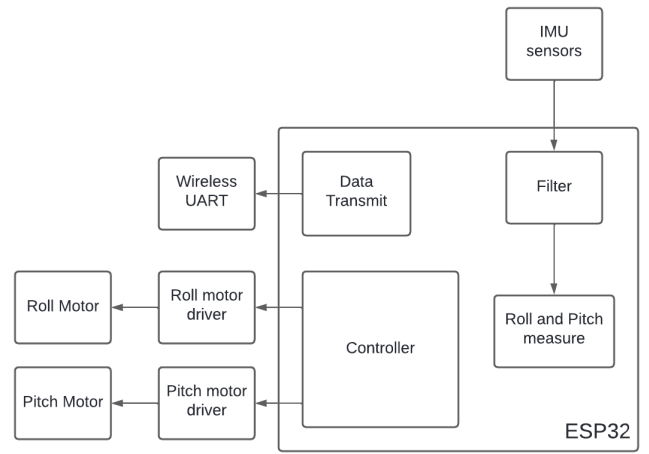

Fig. 8. flowchart of implementation

A. Roll and Pitch angles measuring

To measure pitch and roll angles, the ADXL345 accelerometer is utilized for its precision in detecting linear acceleration along three orthogonal axes: X, Y, and Z. The sensor provides raw acceleration data that sum with high noise; to avoid this, a digital filter is used. However, the filter must be fast and efficient; the most common filters are FIR and IIR, and the response of those filters depends on the number of coefficients, and this number generates the delay response. To save processing and get a fast response, a variation of the exponential moving average filter can be used. The output of this filter is given by (4).

$$y[0] = \frac{y[-1] * N + x[0]}{N + 1} \quad (4)$$

After filtering the raw acceleration, the data can be converted into angular measurements. The pitch and roll angles are calculated in (5) (6) respective.

$$Pitch = \arctan\left(\frac{a_y}{\sqrt{a_x^2 + a_z^2}}\right) \quad (5)$$

$$Roll = \arctan\left(\frac{-a_x}{a_z}\right) \quad (6)$$

With this filter, the curve of both angles becomes smooth to keep the controller stable; on the other hand, this filter is still susceptible to noise from vibrations on the platform. The following graphic in Fig. 9 shows the curve of pitch and roll measured during a step response of the P controller; it is possible to see a small mechanical vibration circled in the graphic.

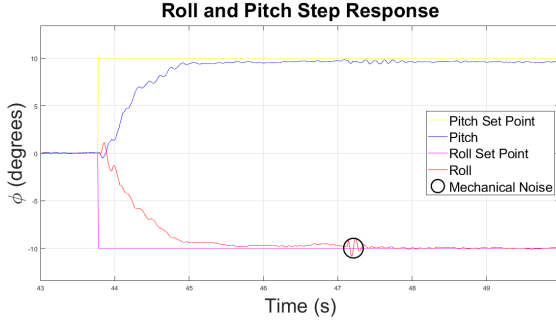

Fig. 9. Step response of the platform

B. Controller

In this platform, the controller must be actuated on the angular position, and this is made by inputting a number of steps in the driver motor, so the number of steps is calculated by converting directly the value of the error, which means a simple P controller can be enough to this problem, the Fig 10 shown the control diagram of the system.

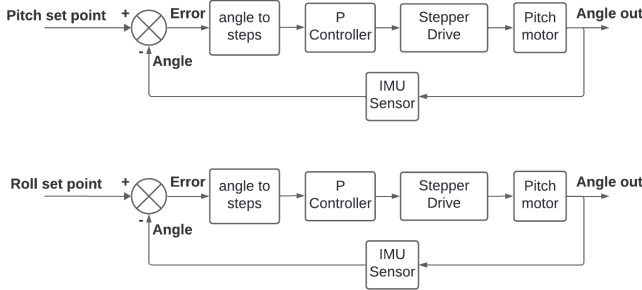

Fig. 10. Control diagram

An important consideration for this controller is the maximum pulse frequency of 250 kHz for the DRV8825 stepper driver, as specified in the datasheet. However, the motor does not respond effectively at this step frequency. Therefore, the controller adjusts the motor speed by calculating the step period based on the error during each controller cycle, so the period of each motor step is calculated by 7.

$$T_{step} = \frac{N_{step}}{T_{controller}} \quad (7)$$

Where the N_{step} is calculated according to the error in 8.

$$N_{step} = \frac{\phi_{err}}{\theta_{step}} \quad (8)$$

Where θ_{step} is the angle per step of the motor, this is a constant calculated by the motor datasheet divided per micro-steps of the driver DRV8825. And the $T_{controller}$ is the period of the digital P controller. In this work, the angle per step in the motor datasheet is 1.8 degrees, the micro steps are configured to 32, and the P controller period is 10 ms.

Furthermore, the digital controller needs to respond promptly. However, considering the motor's lower response rate, a period of 10 ms has been established between controller cycles. This period is also utilized as the sampling interval for the sensors. In Fig. 9 the controller got a response without an overshoot, according to this step response, the rise time and settling time is following to the table II. In another test with more step responses is visible the controller has small overshoots and noise during the rise time. In Fig. 11 is visible the cited behavior.

TABLE II
RISE TIME AND SETTLING TIME

	pitch	roll
t_r	0.83	0.91
t_s	4.75	6.99

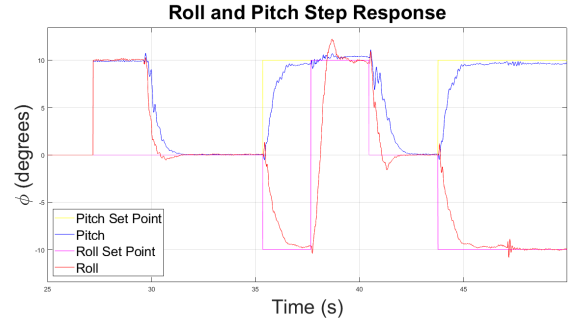

Fig. 11. Sequentially Step responses

In the Fig. 11 the controller gain was set 0.8, some quick tests with gains less than 1 kept the system stable, and tests with gains greater than 1 increased the overshoot and generated a small noticeable oscillation in steady state.

V. CONCLUSION AND FUTURE WORKS

This paper presented a prototype for a bidirectional platform that features simple kinematics with 38 degrees of stabilization in total, from the smallest negative angle to the highest positive angle. The simple hardware was efficient due to the optimizations carried out, mainly in signal filtering and a simple P controller. The tests demonstrated a stabilization of pitch angle faster than roll, but the difference is not huge due to the roll angle being more susceptible to noise in this system.

As this platform is intended to be mobile, an important test to be carried out in future work is how the accelerometers will

respond to the UGV's acceleration due to the sensor measuring the acceleration in the three axes.

Another critical consideration with the sensors lies in measuring both angles using only one accelerometer, where the influence of vibrations was noticeable. To mitigate this noise, integrating additional sensors and employing sensor fusion techniques could effectively eliminate external influences. Alternatively, implementing a damping system could attenuate mechanical vibrations, further enhancing measurement accuracy and stability.

One important analysis to do in this bidirectional structure is the dynamic behavior of the torque demands on the motors. Therefore, exploring alternative structure models such as delta or Stewart platforms could be compared in future works.

ACKNOWLEDGEMENTS

This work was supported by national funds through FCT/MCTES (PIDDAC): CeDRI, UIDB/05757/2020 (DOI: 10.54499/UIDB/05757/2020) and UIDP/05757/2020 (DOI: 10.54499/UIDP/05757/2020); and SusTEC, LA/P/0007/2020 (DOI: 10.54499/LA/P/0007/2020).

REFERENCES

- [1] Tawfeeq, B. A., Salloom, M. Y., and Alkamachi, A. (2022). "A self-balancing platform on a mobile car". *International Journal of Electrical and Computer Engineering*, 12(6), 5911–5922.
- [2] Adel Aziz, G. (2020). "Stability Control Investigation of a Self-Balancing Platform on the Robot Smart Car Using Navigation Parameters". *IOP Conference Series: Materials Science and Engineering*, 765(1).
- [3] Xuan-Mung, N., Hong, S. K., Nguyen, N. P., Ha, L. N. N. T., and Le, T. L. (2020). "Autonomous quadcopter precision landing onto a heaving platform: New method and experiment". *IEEE Access*, 8, 167192–167202.
- [4] Dalamagkidis, K., Ioannou, S., Valavanis, K., and Stefanakos, E. (n.d.). "A Mobile Landing Platform for Miniature Vertical Take-Off and Landing Vehicles".
- [5] Dalang, F. S., Kulathunga, G., and Khusainov, R. (2023). "Autonomous Landing of an Unmanned Aerial Vehicle on a Mobile Platform". *2023 7th International Conference on Automation, Control and Robots, ICACR 2023*, 151–156. <https://doi.org/10.1109/ICACR59381.2023.10314602>
- [6] Zhang, C., Zhang, B., and Zhang, H. (2021). "Design of Automatic Picking Robot Based on 2-DOF Stabilized Platform". *2021 IEEE International Conference on Mechatronics and Automation, ICMA 2021*, 1152–1157.
- [7] Stampa, M., Jahn, U., Fruhner, D., Streckert, T., and Rohrig, C. (2022). "Scenario and system concept for a firefighting UAV-UGV team". *Proceedings - 2022 6th IEEE International Conference on Robotic Computing, IRC 2022*, 253–256.
- [8] Pasini, D., Jiang, C., and Jolly, M. P. (2022). "UAV and UGV Autonomous Cooperation for Wildfire Hotspot Surveillance". *2022 IEEE MIT Undergraduate Research Technology Conference, URTC 2022*.
- [9] Fue, K. G., Porter, W. M., Barnes, E. M., and Rains, G. C. (2020). "An Extensive Review of Mobile Agricultural Robotics for Field Operations: Focus on Cotton Harvesting. In *AgriEngineering*" (Vol. 2, Issue 1, pp. 150–174). MDPI.
- [10] Atefi, A., Ge, Y., Pitla, S., and Schnable, J. (2021). "Robotic Technologies for High-Throughput Plant Phenotyping: Contemporary Reviews and Future Perspectives". In *Frontiers in Plant Science* (Vol. 12). Frontiers Media S.A.
- [11] Oliveira, L.F.P.; Moreira, A.P.; Silva, M.F. "Advances in Forest Robotics: A State-of-the-Art Survey". *Robotics* 2021, 10, 53.
- [12] Yue Feng, Huiming Wang, Jing Wu, Hanyu Song, and I-Ming Chen. (2020). "Design of a Novel Self-Balancing Mechanism on AGV for Stable Stair Climbing". *IEEE*.
- [13] Grlj, C. G., Krznar, N., and Pranjić, M. (2022). "A Decade of UAV Docking Stations: A Brief Overview of Mobile and Fixed Landing Platforms". In *Drones* (Vol. 6, Issue 1). MDPI. <https://doi.org/10.3390/drones6010017>
- [14] Tawfeeq, B. A., Salloom, M. Y., and Alkamachi, A. (2022). "A self-balancing platform on a mobile car". *International Journal of Electrical and Computer Engineering*, 12(6), 5911–5922. <https://doi.org/10.11591/ijece.v12i6.pp5911-5922>
- [15] de Castro, G. G. R., Santos, T. M. B., Andrade, F. A. A., Lima, J., Haddad, D. B., Honório, L. de M., and Pinto, M. F. (2024). "Heterogeneous Multi-Robot Collaboration for Coverage Path Planning in Partially Known Dynamic Environments". *Machines*, 12(3). <https://doi.org/10.3390/machines12030200>
- [16] Vinícius Pacheco Bachei, Alexandre Santos Brandão, and Mário Sarcinelli-Filho. (2020). "Path-Following with a UGV-UAV Formation Considering that the UAV Lands on the UGV". *2020 International Conference on Unmanned Aircraft Systems (ICUAS)*. Athens, Greece. September.
- [17] Nogar, S. M. (2020). "Autonomous Landing of a UAV on a Moving Ground Vehicle in a GPS Denied Environment". *2020 IEEE International Symposium on Safety, Security, and Rescue Robotics (SSRR)* November 4-6, Abu Dhabi, UAE
- [18] Alkhdher, M., Younes, T., Mohamad, O., and Ali, U. (2020). "Adaptive 6 DOF self-balancing platform for autonomous vehicles". *International Journal of Computing and Digital Systems*, 9(1), 69–75. <https://doi.org/10.12785/ijcds/090107>
- [19] Xiang, H., Yi, J., Zhou, B., Wu, H., and Mou, J. (2021). "A Study of Autonomous Landing of UAV for Mobile Platform". *Proceedings - 2021 International Conference on Intelligent Computing, Automation and Systems, ICICAS 2021*, 455–461. <https://doi.org/10.1109/ICICAS53977.2021.00100>
- [20] Zhang, C., Zhang, B., and Zhang, H. (2021). "Design of Automatic Picking Robot Based on 2-DOF Stabilized Platform". *2021 IEEE International Conference on Mechatronics and Automation, ICMA 2021*, 1152–1157. <https://doi.org/10.1109/ICMA52036.2021.9512645>